



Operating manual
Conductivity measuring device

as of version 1.3

GMH 3431



-  Please carefully read these instructions before use!
-  Please consider the safety instructions!
-  Please keep for future reference!



WEEE-Reg.-Nr. DE 93889386

Index

1	GENERAL NOTE	3
2	SAFETY	3
2.1	INTENDED USE	3
2.2	SAFETY SIGNS AND SYMBOLS.....	3
2.3	SAFETY GUIDELINES.....	3
3	PRODUCT SPECIFICATION	4
3.1	SCOPE OF SUPPLY	4
3.2	OPERATION AND MAINTENANCE ADVICE.....	4
4	HANDLING	5
4.1	DISPLAY ELEMENTS.....	5
4.2	PUSHBUTTONS.....	5
4.3	CONNECTIONS	5
4.4	POP-UP CLIP	6
5	START OPERATION	6
6	PRINCIPLES OF THE MEASUREMENTS	7
6.1	BASICS ABOUT CONDUCTIVITY	7
6.2	CONDUCTIVITY MEASUREMENT	7
6.3	RESISTIVITY MEASUREMENT	7
6.4	TDS MEASUREMENT.....	7
6.5	SALINITY MEASUREMENT.....	7
6.6	ELECTRODES / MEASURING CELLS	8
6.6.1	<i>Design</i>	8
6.6.2	<i>Calibration / Adjustment of measuring cells</i>	8
6.7	TEMPERATURE COMPENSATION	8
6.7.1	<i>Temperature compensation “nLF” according to EN 27888</i>	8
6.7.2	<i>Linear temperature compensation and determination of temperature coefficient “t.Lin”</i>	8
7	CONFIGURATION	9
8	ADJUSTMENT OF TEMPERATURE INPUT	10
9	REAL TIME CLOCK (“CLOC”)	10
10	AUTOMATIC ADJUSTMENT/CALIBRATION OF CELL CORRECTION	10
11	GLP	11
11.1	CALIBRATION INTERVAL (C.INT).....	11
11.2	CALIBRATION STORAGE (READ CAL).....	11
12	ACCURACY CHECK / ADJUSTMENT SERVICE	12
13	UNIVERSAL OUTPUT	12
13.1	SERIAL INTERFACE	12
14	ERROR AND SYSTEM MESSAGES	13
15	RESHIPMENT AND DISPOSAL	14
15.1	RESHIPMENT	14
15.2	DISPOSAL INSTRUCTIONS.....	14
16	SPECIFICATION	14
	<i>WHEN OPERATING WITH EXTERNAL SUPPLY OR CONNECTED INTERFACE AND MEASUREMENT AT SOLUTIONS WITH EARTH CONNECTION, THERE MAY APPEAR DISTORTIONS OR DEVIATIONS OF THE MEASURING. IN CASE OF DOUBT DISCONNECT SUPPLY/INTERFACE. THE SAME IS VALID FOR THE ANALOGUE OUTPUT: DEPENDING HOW THE OUTPUT IS CONNECTED (E.G. EVEN WITHOUT ISOLATION), IN CASE OF DOUBT DO NOT MEASURE IN SOLUTIONS WITH EARTH CONTACT.</i>	15

1 General Note

Read this document carefully and get used to the operation of the device before you use it. Keep this document within easy reach near the device for consulting in case of doubt.

2 Safety

2.1 Intended Use

The device is designed for measuring conductivity, resistivity, salinity and TDS in fluids – using a permanently connected electrode (measuring cell).

It is designed for the mobile use or the stationary operation in a controlled electromagnetic environment (lab).

Personnel which starts up, operates and maintains the device has to have sufficient knowledge of the measuring procedure and the meaning of the resulting measured values, this manual delivers a valuable help for this. The instructions of the manual have to be understood, regarded and followed.

To be sure that there's no risk arising due to misinterpretation of measured values, the operator must have further knowledge in case of doubt - the user is liable for any harm/damage resulting from misinterpretation due to insufficient knowledge.

The manufacturer will assume no liability or warranty in case of usage for other purpose than the intended one, ignoring this manual, operating by unqualified staff as well as unauthorized modifications to the device.

2.2 Safety signs and symbols

Warnings are labelled in this document with the followings signs:



Caution! This symbol warns of imminent danger, death, serious injuries and significant damage to property at non-observance.



Attention! This symbol warns of possible dangers or dangerous situations which can provoke damage to the device or environment at non-observance.



Note! This symbol point out processes which can indirectly influence operation or provoke unforeseen reactions at non-observance.

2.3 Safety guidelines

This device has been designed and tested in accordance with the safety regulations for electronic devices. However, its trouble-free operation and reliability cannot be guaranteed unless the standard safety measures and special safety advises given in this manual will be adhered to when using the device.

1. Trouble-free operation and reliability of the device can only be guaranteed if the device is not subjected to any other climatic conditions than those stated under "Specification".

If the device is transported from a cold to a warm environment condensation may cause in a failure of the function. In such a case make sure the device temperature has adjusted to the ambient temperature before trying a new start-up.

2.  If there is a risk whatsoever involved in running it, the device has to be switched off immediately and to be marked accordingly to avoid re-starting.

Operator safety may be a risk if:

- there is visible damage to the device
- the device is not working as specified
- the device has been stored under unsuitable conditions for a longer time.

In case of doubt, please return device to manufacturer for repair or maintenance.

3. When connecting the device to other devices the connection has to be designed most thoroughly as internal connections in third-party devices (e.g. connection GND with protective earth) may lead to undesired voltage potentials that can lead to malfunctions or destroying of the instrument and the connected devices.



This device must not be run with a defective or damaged power supply unit.
Danger to life due to electrical shock!

4.



Do not use these products as safety or emergency stop devices or in any other application where failure of the product could result in personal injury or material damage. Failure to comply with these instructions could result in death or serious injury and material damage.

5.



This device must not be used at potentially explosive areas! The usage of this device at potentially explosive areas increases danger of deflagration, explosion or fire due to sparking.

3 Product Specification

3.1 Scope of supply

The scope of supply includes:

- GMH 3431, incl. 9V-battery
- Operating manual

3.2 Operation and maintenance advice

1. Battery operation:

If  and 'bAt' is shown in the lower display the battery has been used up and needs to be replaced. However, the device will operate correctly for a certain time. If 'bAt' is shown in the upper display the voltage is too low to operate the device; the battery has been completely used up.



*The battery has to be taken out, when storing device above 50°C. We recommend taking out battery if device is not used for a longer period of time.
After recommissioning the real-time clock has to be set again.*

2. Treat device and sensor carefully. Use only in accordance with above specification. (do not throw, hit against etc.). Protect plug and socket from soiling.

3. Mains operation with power supply:



When using a power supply please note that operating voltage has to be 10.5 to 12 V DC. Do not apply overvoltage!! Cheap 12V-power supplies often have excessive no-load voltage. We, therefore, recommend using regulated voltage power supplies.

Trouble-free operation is guaranteed by our power supply GNG10/3000.
Prior to connecting the power supply to the mains make sure that the operating voltage stated at the power supply is identical to the mains voltage.

4 Handling

4.1 Display elements

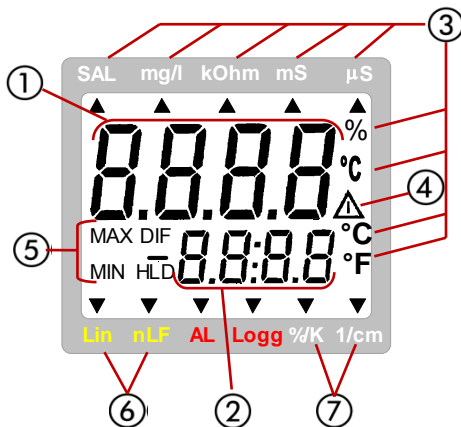

- 1 **Main display:** conductivity (mS/cm, μ S/cm)
resistivity (k Ω cm)
TDS / total dissolved solids (mg/l)
salinity (SAL)

- 2 **Secondary display:** measuring value temperature

- 3 Arrows to selected **measuring unit**

- 4 **Warning signal:** indicates low battery or missing calibration

- 5 Display elements to show minimum / maximum / memorized measuring value

- 6 **nLF, Lin:** display element for selected **temperature compensation**

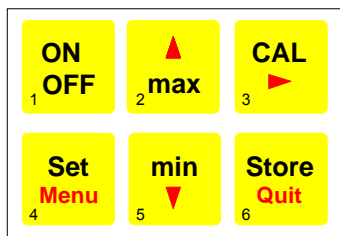

- 7 **%/K, 1/cm:** additional configuration units

4.2 Pushbuttons



-  **On / Off key**
press shortly: switch on/off instrument

-  **Set / Menu:**
press shortly: change-over between measuring units (only if „InP: SEt“ is selected)
press for 2 sec. (menu): invoke configuration menu

-  **min/max when taking measurements:**
press shortly: min. or max. value is displayed
press for 2 sec: the corresponding value is deleted
-  **Configuration:**
to enter values or change settings

-  **CAL:** only at mode 'cond'=conductivity:
press for 2 sec: start cell correction adjustment

-  **Store/Quit:**
Measurement: hold and save current measuring value ('HLD' is displayed)
Set/Menu: confirm settings, return to measuring

4.3 Connections

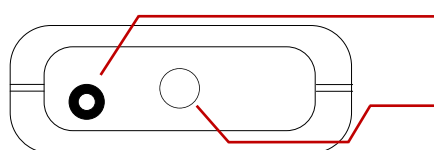

Universal output: interface (see chapter 13 "Universal output")

Permanently connected measuring cell with integrated temperature probe

Power supply:

The mains socket (1,9 mm inner diameter) is located at the left side of the instrument for 10,5-12 V DC supply



All contacts have to be protected against dirt and moisture!

4.4 Pop-up clip

Handling:

- Pull at label "open" in order to swing open the pop-up clip.
- Pull at label "open" again to swing open the pop-up clip further.

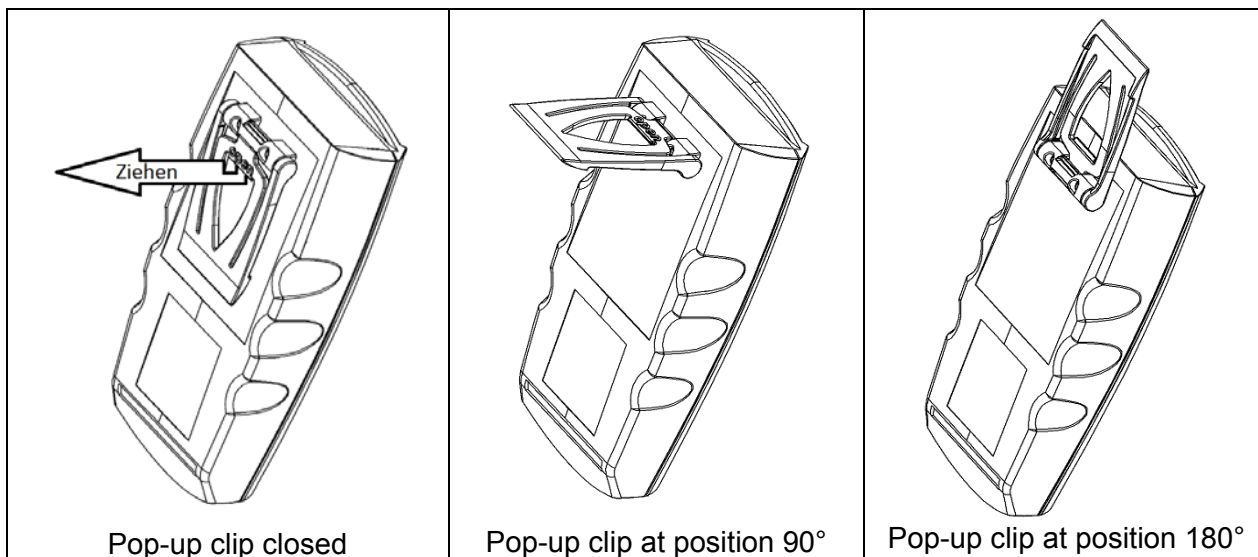

Function:

- The device with a closed pop-up clip can be plainly laid onto a table or attached to a belt, etc.
- The device with pop-up clip at position 90° can be set up on a table, etc.
- The device with pop-up clip at position 180° can be suspended from a screw or the magnetic holder GMH 1300.

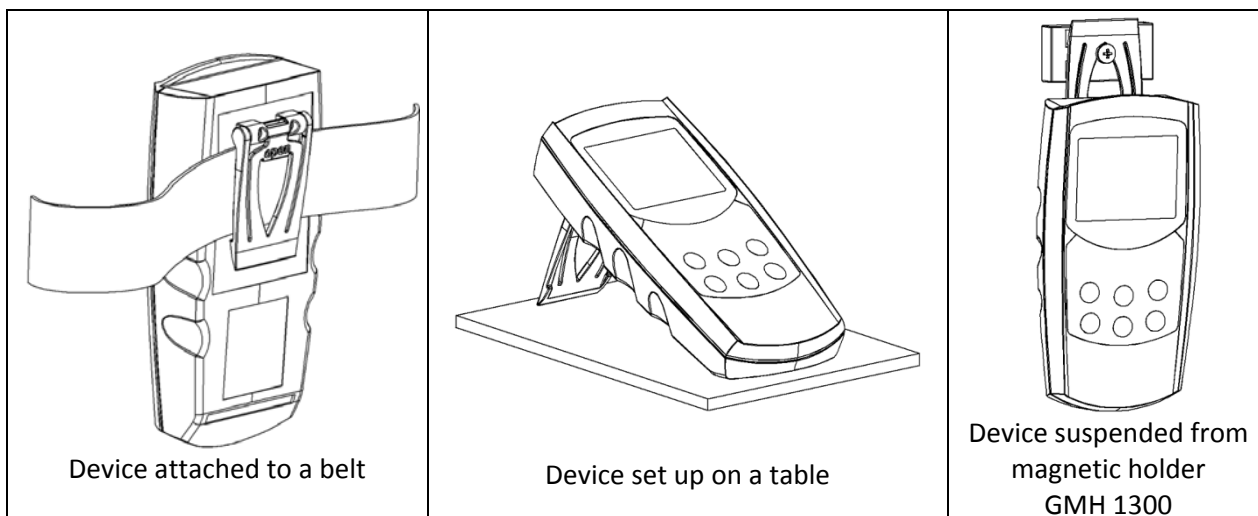

5 Start Operation

Turn device on via  key.

After segment test  the device displays some information on its configuration:

$\overline{500}$ if cell correction scale was changed (cell correction scale unequal 1.000)
(see chapter 10 Automatic adjustment/calibration of cell correction)

\overline{Corr} if zero point or slope correction is active
(see chapter 8 Adjustment of temperature input)

After that the device is ready for measuring.

6 Principles of the measurements

6.1 Basics about conductivity

Definition of conductivity: The ability of a material to conduct electric current: $\gamma = \frac{1}{R \cdot A}$

L: length of the material

A: diameter

R: measured resistance

Unit $[\gamma] = \frac{\text{Siemens}}{\text{meter}} = \frac{\text{S}}{\text{m}}$, common for liquids: $\frac{\text{mS}}{\text{cm}}$ and $\frac{\mu\text{S}}{\text{cm}}$

The conductivity is the reciprocal value of the resistivity.

(The conductance is the reciprocal value of the measured resistance R)

6.2 Conductivity measurement

The conductivity measurement is a rather uncomplicated measurement. The standard electrodes are stable for a long time if used correctly and can be adjusted by an integrated Cal-function.

Measuring ranges: 0.0 - 200.0 $\mu\text{S}/\text{cm}$ | 0 - 2000 $\mu\text{S}/\text{cm}$ | 0.00 - 20.0 mS/cm | 0.0 - 200.0 mS/cm

If the range selection is set to „Auto Range“, the range with the best resolution is automatically selected. In this case, the output value of the interface will always be the measured value with the highest possible resolution (e.g. display value: 187.6 mS/cm \Rightarrow interface output: 187600.0 $\mu\text{S}/\text{cm}$).

6.3 Resistivity measurement

The resistivity is the reciprocal value of the conductivity and the device displays it in $\text{k}\Omega \cdot \text{cm}$.

Measuring ranges: 0.000 - 2.000 $\text{k}\Omega \cdot \text{cm}$ | 0.00 - 20.00 $\text{k}\Omega \cdot \text{cm}$ | 0.0 - 100.0 $\text{k}\Omega \cdot \text{cm}$

If the range selection is set to „Auto Range“, the range with the best resolution is automatically selected. In this case, the output value of the interface will always be the measured value with the highest possible resolution (e.g. display value: 18.76 $\text{k}\Omega \cdot \text{cm}$ \Rightarrow interface output: 18.760 $\text{k}\Omega \cdot \text{cm}$).

6.4 TDS measurement

At the TDS (total dissolved solids) measurement the filtrate dry residue is determined by means of the conductivity and a conversion factor (C.tdS). Well suited for easy concentration measurements of e.g. salt solutions. The determined value is displayed in mg/l .

Measuring ranges: 0.0 - 200.0 mg/l | 0 - 2000 mg/l

If the range selection is set to „Auto Range“, the range with the best resolution is automatically selected. In this case, the output value of the interface will always be the measured value with the highest possible resolution (e.g. display value: 1876 mg/l \Rightarrow interface output: 1876.0 mg/l).

Displayed value TDS = conductivity [in $\mu\text{S}/\text{cm}$, nLF-temp. comp. at 25°C] • C.tdS (input at menu)

Approximately:

C.tdS	
0.50	Monovalent salts with 2 ion types (NaCl, KCl, etc.)
0.50	Natural waters / surface waters, drinking water
0.65 - 0.70	e.g. salt concentration of aqueous fertilizer solutions

Attention: This are only approximate values – good for estimations, but no precise measurement.

For precise measurements the conversion value has to be determined for the corresponding solution for the relevant concentration range.

This may be done by comparison with known reference solutions or by actually evaporating a certain amount of solution with determined conductivity and subsequent weighing of the dry residue.

6.5 Salinity measurement

At the salinity measurement “SAL” the salinity (salt content) of seawater is determined (based on: International Oceanographic Tables; IOT). Standard seawater has a salinity of 35 ‰ (35 g salt per 1 kg seawater).

Commonly the measured value is displayed dimensionless in ‰ (g/kg).

Additionally the term “PSU” (Practical Salinity Unit) is sometimes used, the displayed value is the same.

The salinity measurement has its “own” temperature compensation, i.e. the temperature is automatically taken into account for the salinity measurement. The menu settings regarding the temperature compensation are ignored.



The salt composition of the different seas is not the identical. Depending on place, weather, tides, etc. there may be considerable divergences to the 35 ‰ according to IOT. Additionally the salt composition may influence the ratio between salinity and actual salt content.

6.6 Electrodes / Measuring Cells

6.6.1 Design

Basically there are two types of measuring cells: 2-pole and 4-pole cells. The operation is done similarly; the 4-pole measuring cells can compensate polarization effects and – up to some degree – soiling due to its complex measuring method.

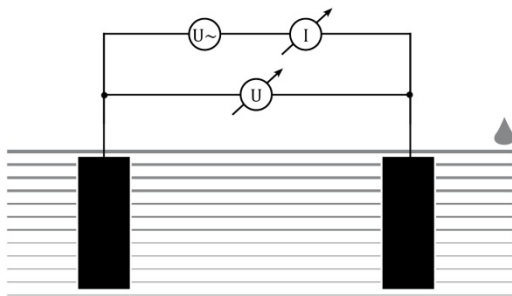

2-pole measuring cell

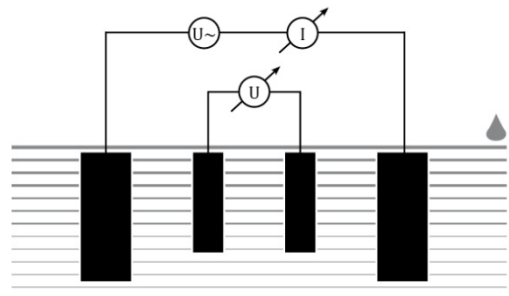

4-pole measuring cell

6.6.2 Calibration / Adjustment of measuring cells

Especially in harsh environments and over long time the cell constants of measuring cells are drifting. Depending on the application and use we recommend a regular checking of the precision of the measuring chain: instrument + cell. For this there are control solutions available (GKL 100, 101, 102). At normal use a checking each half year is recommended (see chapter 10 Automatic adjustment/calibration of cell correction). A system check at the manufacturer is recommended in case of doubt: see chapter 12 Accuracy Check / Adjustment Service).

6.7 Temperature compensation

The conductivity of aqueous solutions depends on its temperature. The temperature dependency is strongly dependent on the type of solution. The temperature compensation recalculates solutions' conductivity to a consistent reference temperature. The most common reference temperature is 25 °C.

6.7.1 Temperature compensation “nLF” according to EN 27888

For most applications (e.g. in the area of fish farming, surface or drinking water measurements, etc.) the non-linear temperature compensation for natural water (“nLF”, according to EN 27888) is sufficiently accurate.

The common reference temperature is 25 °C.

Recommended application range of nLF-compensation: between 60 µS/cm and 1000 µS/cm.

6.7.2 Linear temperature compensation and determination of temperature coefficient “t.Lin”

If the actual function needed for exact temperature compensation is not known, “linear temperature compensation” is normally selected (Menu, t.Cor = Lin, t.Lin corresponds TK_{lin}), i.e. one assumes that the actual temperature dependency at the considered concentration range is approximately equal:

$$LF_{T_{ref}} = \frac{LF_{T_x}}{1 + \frac{TK_{lin}}{100\%} \cdot (T_x - T_{ref})}$$

Temperature coefficient of about 2.0 %/K are most common.

A temperature coefficient can be determined for example by measuring a solution with deactivated temperature compensation at two different temperatures (T1 and T2).

$$TK_{lin} = \frac{(LF_{T_1} - LF_{T_2}) \cdot 100\%}{(T_1 - T_2) \cdot LF_{T_1}}$$

TK_{lin} is the value input at the menu “t.Lin”.





LF_{T_1} conductivity at temperature T1





LF_{T_2} conductivity at temperature T2

7 Configuration



Some menu points depend on current device settings.





To change device's settings, press „Menu“  for 2 seconds. This will activate the configuration menu (main display: "SET"). Pressing „Menu“  changes between the menus points, pressing  jumps to the referring parameters, which can be selected with key .













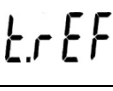
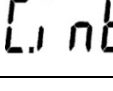

The parameter value can be changed with  or . Pressing „Menu“  again jumps back to the main configuration menu and saves the settings. Pressing „Quit“  finishes the configuration.

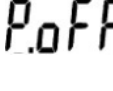

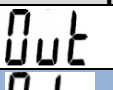
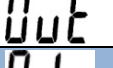
Pressing "menu" and "store" at the same time for more than 2 seconds will reset the device to factory defaults.

If no key is pressed for more than 2 minutes the configuration will be aborted. All changes will be discarded!

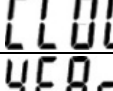
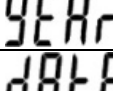
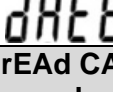
Menu	Parameter	Value	Description
		 or 	
SET [conf]	Set Configuration: General configuration		
InP	Input: Selection of measured variable		
	Cond	Conductivity	
	rESi	Resistivity	
	tdS	Total dissolved solids	
	SAL	Salinity	
	SEt	Change-over measured variables by Set-key	
CLDS	TDS measurement: conversion factor (only if Inp = tdS)		
	0.40 - 1.00	Conversion factor for TDS measurement	
CELL [Corr]	Cell Corr: Adjustment of cell correction: multiplication factor		
	0.800 - 1.200	Multiplication factor of cell correction Factory setting: 1.000	
rRnG	Range: Selection of display range (conductivity, resistivity or tdS)		
	Auto	Automatic range selection	
	200.0 µS/cm	Lowest selectable range (conductivity)	
	400 mS/cm	Highest selectable range (conductivity)	
CAL	Automatic adjustment/calibration with reference solution (only if Inp = Cond)		
	Edit	Manual adjustment to reference value	
	REF.S	Choice of standard reference solutions	
rEFFS	REF.S: Choice of standard reference solutions for automatic adjustment/cal.		
	1413 µS/cm	Reference solution 0.01 M KCL	
	2760 µS/cm	0.02 M KCL	
	12.88 mS/cm	0.1 M KCL	
	50 mS/cm	Sea-water reference solution KCL	
Unit t	Unit t: Selection of temperature unit		
	°C	All temperature values in degree Celsius	
tCor	Temperature compensation (not for InP = SAL)		
	oFF	No temperature compensation of conductivity measurement	
	nLF	Non-linear function for natural waters according to EN 27888 (ISO 7888), ground, surface and drinking water	
	Lin	Linear temperature compensation	
tLin	Compensation coefficient (only if t.Cor = Lin)		
	0.300 3.000	Temperature compensation coefficient in %/K	

Menu	Parameter	Value	Description
		 OR 	
		Reference temperature of temperature compensation (only if t.Cor = Lin or nLF)	
		25 °C / 77 °F	Reference temperature 25 °C / 77 °F
		20 °C / 68 °F	Reference temperature 20 °C / 68 °F
		Adjustment/Calibration: Adjustment reminder period (factory setting: oFF)	
1 ...730 oFF		Adjustment reminder period (in days) No adjustment reminder	
	Auto Hold: Automatic measuring value identification		
	on oFF	Auto measuring value identification Auto Hold Standard hold function on key press	
	Auto Power-Off : Selection of power-off delay		
	1...120 oFF	Power-off delay in minutes. Device will be automatically switched off as soon as this time has elapsed if no key is pressed/no interface communication takes place. Automatic power-off function deactivated (continuous operation)	
	Set Output: Configuration of universal output		
		oFF	Output off -> minimal power consumption
		SEr:	Serial interface activated
	Set Corr: Measurement correction		
		Zero point adjustment / offset of temperature measurement	
		oFF	No zero point adjustment for temperature measurement
	-5.0 ... 5.0°C	Offset of temperature measurement in °C	
	Slope adjustment of temperature measurement		
	oFF	No slope adjustment for temperature measurement	
	-5.00 ... 5.00	Slope correction of temperature measurement in [%]	
	Set Clock: Setting of real time clock		
		HH:MM	Clock: set time hours:minutes
		YYYY	Year: set year
		TT.MM	Date: set date day.month
	rEAd CAL: Read calibration data: see chapter 11.2 Calibration storage (rEAd CAL)		

8 Adjustment of temperature input

The temperature input can be adjusted with offset and scale. A reasonable adjustment presumes reliable references (e.g. ice water, controlled precision water bath, etc.).

If the inputs are adjusted (i.e. offset and scale are different from default settings) the device will shortly display "Corr" after turned on.

Default setting for offset and scale are 'off' = 0.0, i.e. inputs are not changed.

Zero point correction: **Displayed value = measured value – OFFS**

Zero point and slope correction: **Displayed value = (measured value – OFFS) * (1 + SCAL / 100)**
Displayed value °F = (meas. value °F - 32°F - OFFS) * (1 + SCAL / 100)

9 Real Time Clock ("CLOC")

The real time clock is used for chronological assignment of the calibration points. Please check the settings when necessary.

10 Automatic adjustment/calibration of cell correction

Besides the direct input of the cell correction (see below) via the menu ("CELL Corr") the cell correction can also be determined automatically:

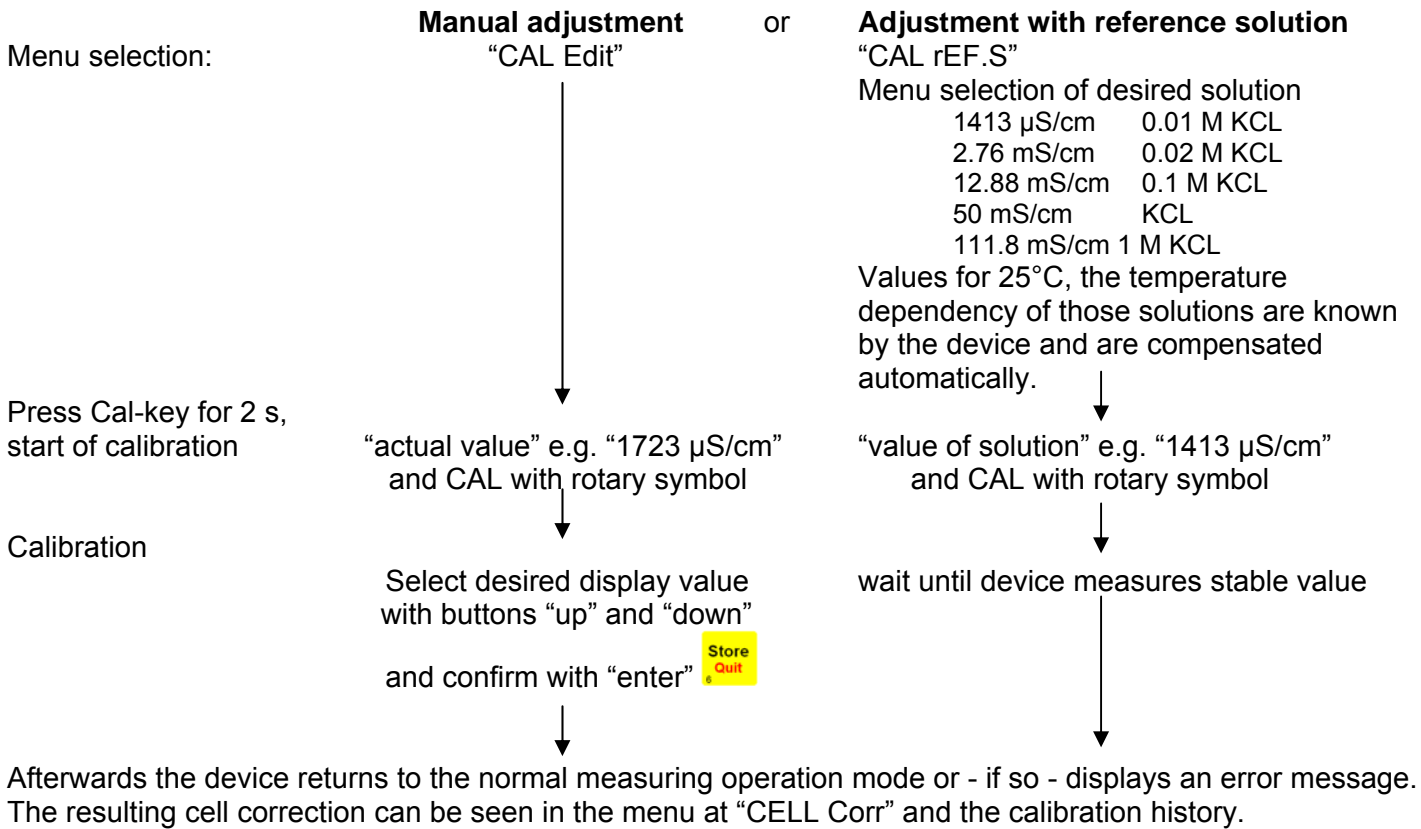

Error messages of automatic adjustment/calibration:

CAL Err.1	Cell correction too high	Determined cell correction must not exceed 1.2
CAL Err.2	Cell correction too small	Determined cell correction must not fall below 0.8
CAL Err.3	Solution of wrong range	Wrong solution / far beyond tolerance
CAL Err.4	Wrong temperature	Beyond permitted temperature: 0.0 – 34.0 °C (or 0.0 – 27.0 °C at 111.8 mS/cm)

Alternative to automatic adjustment:

Manual calculation of cell correction with a reference solution

Example KCl-solution $c = 0.01 \text{ M}$: $1413 \text{ } \mu\text{S cm}^{-1}$ at 25°C

At other temperatures switch temperature compensation off ($t.\text{Cor} = \text{oFF}$) and use the referring conductivity!

Conductivity_{displayed} = $1500 \text{ } \mu\text{S cm}^{-1}$ if selected cell correction is 1.000 cm^{-1} (CELL Corr = 1.000)

Conductivity of solution at solution temperature 25°C : Conductivity_{real} = $1413 \text{ } \mu\text{S cm}^{-1}$

Cell correction $c = \text{conductivity}_{\text{real}} / \text{conductivity}_{\text{displayed}} [\text{cm}^{-1}]$
 $= 1413 / 1970 * \text{cm}^{-1} = \mathbf{0.942 \text{ cm}^{-1}}$ (Enter CELL Corr of 0.942)

11 GLP

GLP (Good Laboratory Practice) includes regular check of devices and accessories. For pH measurements it is highly important to ensure correct pH calibration. The device provides the following functions to help with this.

11.1 Calibration interval (C.Int)

You can input the interval after which the device reminds you to recalibrate.

The interval times should be chosen according to the application and the stability of the electrode. "CAL" flashes on the display as soon as the interval has expired.

11.2 Calibration storage (rEAd CAL)

The last 16 calibrations are stored with results and date and can be read out.

Display calibration data:



Historical calibration data can be comfortably read out via PC software GMHKonfig and GSOF3050 or displayed directly at the device:

Press for 2 seconds:
The display will show: 

Press several times until this is displayed:  read cal. = "read calibration data"

Press shortly: switch between:

- CELL = cell correction
- C.rEF = reference value, at which cell correction has been adjusted
- Display of date+time of data set

 OR  Change between the different calibration data sets

 Quit calibration data set display

12 Accuracy Check / Adjustment Service

You can send the device to the manufacturer for adjustment and inspection.

Calibration certificate - DKD certificate - official certifications:

If the measuring instrument is supposed to receive a calibration certificate, it has to be sent to the manufacturer (declare test points).

If the device is certificated together with a suitable sensor very high overall accuracies are possible.

Basic settings can only be checked and – if necessary – corrected by the manufacturer.

A calibration protocol is enclosed to the device ex works. This documents the precision reached by the production process.

13 Universal output

If none of both is needed, we suggest to switch the output off, because battery life then is extended.



When operating with external supply or connected interface and measurement at solutions with earth connection, there may appear distortions or deviations of the measuring. In case of doubt disconnect supply/interface.

The same is valid for the analogue output: Depending how the output is connected (e.g. even without isolation), in case of doubt do not measure in solutions with earth contact.

13.1 Serial Interface

By means of the serial interface and a suitable electrically isolated interface adapter (USB 3100, USB 3100 N, GRS 3100 or GRS 3105) the device can be connected to a computer for data transfer.

With the GRS 3105 up to 5 devices of the GMH3xxx- series can be connected to one interface (see also manual of GRS 3105). As a precondition the base addresses of all devices must not be identical, make sure to configure the base addresses accordingly (refer menu point "Adr." in chapter 8 "Configuration").

To avoid transmission errors, there are several security checks implemented e.g. CRC.

The following standard software packages are available:

- **GSOFT3050:** Operation and read out of logger function, data display in diagrams and tables
- **GMHKonfig:** Software for a comfortable editing of the device (e.g. Material selection...)
- **EBS 20M / 60M:** 20-/60-channel software to display the measuring values

In case you want to develop your own software we offer a **GMH3000-development package** including:

- A universally applicable Windows functions library ('GMH3000.DLL') with documentation that can be used by the most programming languages. Suitable for Windows XP™, Windows Vista™, Windows 7™, Windows 8 / 8.1™, Windows 10™
- Programming examples Visual Studio 2010 (C#, C++ and VB), Testpoint™, LabView™ etc.

The device has 2 channels:

- Channel 1: current measuring value Cond, rES, TDS or SAL (base address)
- Channel 2: temperature value

Supported functions:

1	2	Code	Name/Function	1	2	Code	Name/Function
x	x	0	Read measurement value	x	x	200	Read min display range
x	x	3	Read system state	x	x	201	Read max display range
x		12	Read ID number	x	x	202	Read display range - unit

1	2	Code	Name/Function	1	2	Code	Name/Function
				x	x	204	Read display range - decimal point
				x		208	Read # of channels
x	x	176	Read min measuring range	x		222	Read power off time (Conf-P.oFF)
x	x	177	Read max measuring range	x		223	Set power off time (Conf-P.oFF)
x	x	178	Read measuring range unit	x		233	Read real time clock (CLOC)
x	x	179	Read measuring range decimal point	x		234	Set real time clock (CLOC)
x	x	180	Read kind of measuring of sensor	x		240	Reset
x	x	199	Read kind of measuring of display	x		254	Program version



The measuring- and display range values read back from the interface are always in the selected measurement unit!



When using the interface, the auto-range-function should be turned off. If auto-range is activated, the returned value is based on the resolution of the smallest ranges, there may be returned extreme values like 123400.0 µS/cm instead 123.4 mS/cm.

14 Error and System Messages

Error messages for measurement

	Description	What to do?
No display or confused characters, Device does not react on key press	Battery empty	Replace battery
	Mains operation: wrong voltage or polarity	Check power supply, replace it if necessary
	System error	Disconnect battery and power supply, wait shortly, then reconnect
	Device defective	Return to manufacturer for repair
Err.1	Measured value above allowable range	Check: pressure not within sensor range? -> measuring value to high!
	Sensor defective	Return to manufacturer for repair
Err.2	Measured value below allowable range	Check: pressure not within sensor range? -> measuring value to low!
	Sensor defective	Return to manufacturer for repair
Err.7	System error	Return to manufacturer for repair
	Value extremely out of measuring range	Value extremely out of measuring range
----	Could not calculate display value	
	• measuring range or input range exceeded	Check range parameter
	• measured values are instable	Wait for signal regulation of the device
> CAL < CAL flashing in upper display	Either preset calibration interval has expired or last calibration is not valid	Device has to be calibrated!

Error messages for automatic cell correction adjustment/calibration:

CAL Err.1	Cell correction too high	Determined cell correction must not exceed 1.2
CAL Err.2	Cell correction too small	Determined cell correction must not fall below 0.8
CAL Err.3	Solution of wrong range	Wrong solution / far beyond tolerance
CAL Err.4	Wrong temperature	Beyond permitted temperature: 0.0 – 34.0 °C (or 0.0 – 27.0 °C at 111.8 mS/cm)

If “bAt” is flashing the battery will be exhausted soon. Further measurements are possible for short time. If “bAt” is displayed continuously the battery is ultimately exhausted and has to be replaced. Further measurements aren't possible any more.

15 Reshipment and Disposal

15.1 Reshipment



All devices returned to the manufacturer have to be free of any residual of measuring media and other hazardous substances. Measuring residuals at housing or sensor may be a risk for persons or environment



Use an adequate transport package for reshipment, especially for fully functional devices. Please make sure that the device is protected in the package by enough packing materials.

15.2 Disposal instructions



Batteries must not be disposed in the regular domestic waste but at the designated collecting points.

The device must not be disposed in the unsorted municipal waste! Send the device directly to us (sufficiently stamped), if it should be disposed. We will dispose the device appropriate and environmentally sound.

16 Specification

Measuring ranges	Count	5
	Conductivity 1 *)	0,0 ... 200,0 µS/cm
	” 2 *)	0 ... 2000 µS/cm
	” 3 *)	0,00 ... 20,00 mS/cm
	” 4 *)	0,0 ... 200,0 mS/cm
	Resistivity	0,005 ... 100,0 kOhm*cm
	TDS	0,0 ... 1999 mg/l
	Salinity	0,0 ... 70,0 g/kg (PSU)
Temperature		-5,0 ... +100,0 °C
		23,0 ... 212,0 °F
Accuracy	Conductivity	±0,5% v.MW ±0,3 % FS or ±2 µS/cm
	Temperature	±0,2 K
Connections	Conductivity, Temperature	Permanently connected measuring cell
	Output	Serial interface (3.5mm jack) can be connected to USB or RS232 interface of a PC via electrically isolated interface adapter USB3100, USB 3100 N, GRS3100 or GRS3105 (see accessories).
Measuring cell		Two-electrode-conductivity-measuring cell with integrated temperature sensor
	Electrode material	special graphite
	Shaft material	polysulfon
	Dimensions	dia. 12 mm, length 120 mm
Ambient condition		-5 ... +80°C (continuous) to +100°C (short-duration)
Display		4 digit 7-segment (main and secondary display) with additional symbols
Additional functions		Min / max / hold
Adjustment/Calibration		Cell correction manually or automatically via selectable reference solution
Housing		Break-proof ABS housing
	Protection class	Front side IP65
	Dimensions L*W*H [mm]	142 x 71 x 26 mm (L x W x H)
Working conditions		-25 to 50 °C; 0 to 95 % RH (non condensing)
Storage temperature		-25 to 70 °C
Power supply		9V-battery, typ IEC 6F22 (included in scope of supply) or external
	Current consumption	2 mA (Out = Off)
	Battery indicator	Automatically if battery exhausted Δ and ' bAt '
Auto-Off-Function		Device will be automatically switched off if no key is pressed/no interface communication takes place for the time of the power-off delay. The power-off delay can be set to values between 1 and 120 min.; it can be completely deactivated.
Directives and standards		The instruments confirm to following European Directives: 2014/30/EU EMC Directive 2011/65/EU RoHS Applied harmonized standards: EN 61326-1 : 2013 emissions level: class B emi immunity according to table 3 and A.1 Additional fault: <1%